

D'ANDREA MONOD'

- INDEX
- СОДЕРЖАНИЕ
- SPIS TREŚCI
- REJSTRIK
- DİZİN

p. 240



p. 194

DIN 69893 HSK-A

ER
WD
PF
CM
MS

p. 240



p. 198

DIN 69871 AD+B

ER
WD
PF
CM
MS

p. 240



p. 204

MAS 403 BT AD+B

ER
WD
PF
CM
MS

192



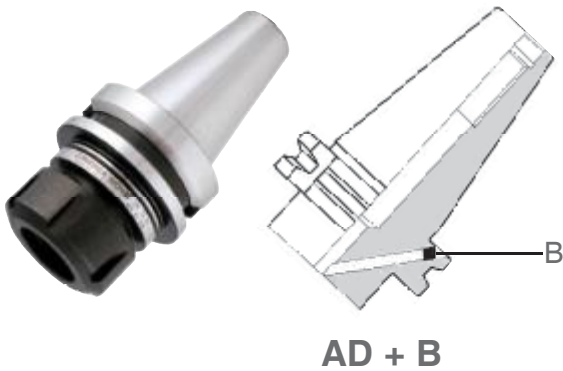

*Quality, precision,
strength and convenience*

- INTEGRATED TOOLHOLDERS
- ИНТЕГРАЛЬНЫЕ ДЕРЖАТЕЛИ
- ZINTEGROWANE OPRAWKI NARZĘDZIOWE
- INTEGROVANÉ NÁSTROJOVÉ DRŽÁKY
- ENTEGRE TAKIM TUTUCULAR

GB The integrated MONOd' tool holders represent an ideal solution to equip any type of machine tool with HSK 63 and 100, DIN AD+B and BT AD+B base arbors, guaranteeing the benefits of a high quality and high precision, with a price that is highly competitive on the market. The MONOd' program includes ER collet chucks, Weldon end mill holders, Morse tapers, and tapping chucks.

RU Интегральные Держатели MONOd' представляют собой идеальное решение для оснащения любого станка с переходными втулками HSK 63 и 100, DIN AD+B и BT AD+B, обеспечивая преимущества высокого качества и значительный уровень точности исполнения в сочетании с конкурентоспособными ценами. Программа MONOd' включает в себя цанговые патроны ER, Weldon, оправки для насадных фрез, переходники Морзе и метчики.

PL Linia zintegrowanych oprawek narzędziowych MONOd' jest idealną propozycją wyposażenia obrabiarek z oprawką podstawową HSK 63 i 100, DIN AD+B oraz BT AD+B, zapewniając użytkownikowi wysoką jakość i duży stopień dokładności, przy zachowaniu konkurencyjnej ceny. Program MONOd' zawiera tulejki ER, Weldon, oprawki frezarskie, tuleje redukcyjne Morse'a oraz gwintowniki.

CZ Integrované nástrojové držáky MONOd' představují ideální řešení pro vybavení jakéhokoliv typu obráběcího stroje základními vřeteny HSK 63 a 100, DIN AD+B a BT AD+B, které zaručuje výhody vysoké kvality a vysoké přesnosti a s cenou, která je na trhu vysoce konkurenceschopná. Program MONOd' zahrnuje pouzdřové upínáky ER, koncové frézovací držáky Weldon, kužely Morse a závitorezné upínáky.

TR Entegre MONOd' takım tutucular, HSK 63 ve 100, DIN AD+B ve BT AD+B temel malafalı her çeşit işleme takımının kullanılabilmesi için ideal bir çözüm sunarak yüksek kalite ve hassasiyetin tüm avantajlarını piyasadaki en avantajlı fiyatlarla ayağınıza getirir. MONOd' programı ER freze çakısı tutacaklı aynaları, Weldon uç mili tutucuları, Mors konikler ve dış açma torna aynalarını içerir.

- COLLET CHUCK HOLDER
- ЦАНГОВЫЕ ПАТРОНЫ
- OPRAWKA TULEI ZACISKOWEJ
- ROUZDROVÝ UPINACÍ DRŽÁK
- FREZE ÇAKISI TUTUCULU TORNA AYNASI TUTUCU

DIN 69893 HSK-A
ER - DIN 6499

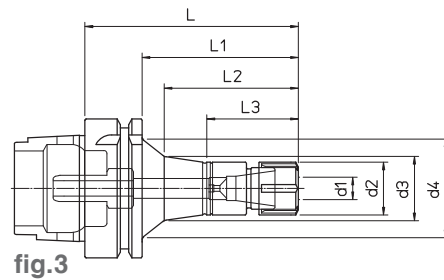
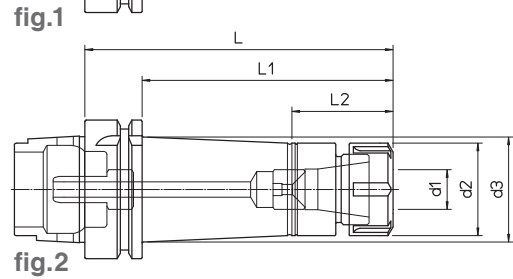
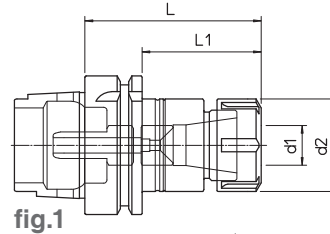

- Supplied with coolant tube - without collets and clamping wrenches
- Эластичная цанга и зажимный ключ не входят в комплект поставки
- Wyposażona w złączkę do cieczy chłodzącej – Tuleja elastyczna i klucze zaciskowe nie są na wyposażeniu
- Dodává se s potrubím chladiva - bez pouzder a upinacích klíčů
- Soğutma sıvısı borusuyla, çakı tutacağı ve sıkıştırma anahtarları olmadan tedarik edilir

HSK-A	REF.	CODE	TYPE	d ₁	d ₂	d ₃	d ₄	L	L ₁	L ₂	L ₃	kg	fig.
63	HSK-A63 ER16.80	71HСКА063ER1608	ER 16 M	0.5 ~ 10	22	32		80	54	41		1.1	1
	HSK-A63 ER16.120	71HСКА063ER1612				31		120	94			1.9	2
	HSK-A63 ER25.80	71HСКА063ER2508	ER 25	1 ~ 16	42	-		80	54	-		1.3	1
	HSK-A63 ER25.140	71HСКА063ER2514				47.5		140	114	46		1.7	2
	HSK-A63 ER32.90	71HСКА063ER3209	ER 32	2 ~ 20	50	-		90	64	-		1.6	1
	HSK-A63 ER32.160	71HСКА063ER3216				160		134	-	2.2		2	
100	HSK-A100 ER16.100	71HСКА100ER1610	ER 16 M	0.5 ~ 10	22	25	45	100	71	61	41.5	2.3	3
	HSK-A100 ER16.160	71HСКА100ER1616				34.5	44	160	131	126		2.5	
	HSK-A100 ER25.100	71HСКА100ER2510	ER 25	1 ~ 16	42	45.5		100	71	47		2.6	
	HSK-A100 ER25.160	71HСКА100ER2516				49.5		160	131			3.2	
	HSK-A100 ER32.120	71HСКА100ER3212	ER 32	2 ~ 20	50	55		120	91	52		3.1	2
	HSK-A100 ER32.160	71HСКА100ER3216				56.5		160	131			3.7	
	HSK-A100 ER40.120	71HСКА100ER4012	ER 40	3 ~ 26	63	71.5		120	91	60		3.5	

248



242-244

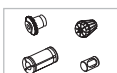

240

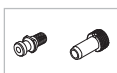

223



- WELDON TOOLHOLDER
- ДЕРЖАТЕЛИ WELDON
- OPRAWKA NARZĘDZIOWA WELDON
- NÁSTROJOVÝ DRŽÁK WELDON
- WELDON TAKIM TUTUCU

DIN 69893 HSK-A
WD - DIN 1835-B

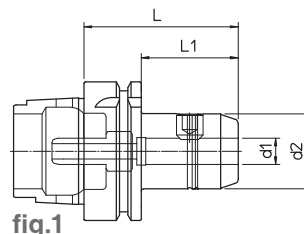

fig.1

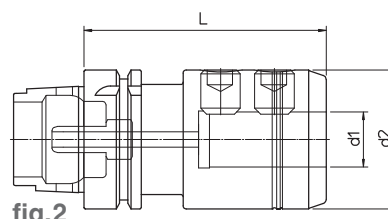

fig.2

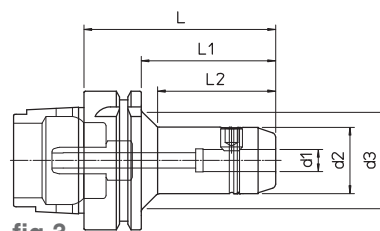

fig.3

- Supplied with coolant tube
- Содержит соединение для хладагента
- Wyposażona w złączkę do cieczy chłodzącej
- Dodávané s chladičím potrubím
- Soğutma sıvısı borusuyla tedarik edilir

HSK-A	REF.	CODE	d1 ^{H5}	d2	d3	L	L1	L2	kg	fig.
63	HSK-A63 WD06.60	71HSKA063WD0606	6	23	-	60	34	-	0.8	1
	HSK-A63 WD08.65	71HSKA063WD0806	8	26		65	39		0.9	
	HSK-A63 WD10.70	71HSKA063WD1007	10	30		70	44		1.1	
	HSK-A63 WD12.70	71HSKA063WD1207	12	34					1.2	
	HSK-A63 WD16.80	71HSKA063WD1608	16	42		80	54		1.4	
	HSK-A63 WD20.80	71HSKA063WD2008	20	50					1.5	
	HSK-A63 WD25.110	71HSKA063WD2511	25	63		110	-		2.3	
	HSK-A63 WD32.110	71HSKA063WD3211	32	70					2.5	
100	HSK-A100 WD10.90	71HSKA100WD1009	10	30	45	90	61	53.5	2.3	3
	HSK-A100 WD12.100	71HSKA100WD1210	12	34		100	71	65.5	2.4	
	HSK-A100 WD14.100	71HSKA100WD1410	14	38				67.5	2.5	
	HSK-A100 WD16.100	71HSKA100WD1610	16	42	-				2.6	1
	HSK-A100 WD18.110	71HSKA100WD1811	18	46		110	81		3	
	HSK-A100 WD20.110	71HSKA100WD2011	20	50					3.1	
	HSK-A100 WD25.120	71HSKA100WD2512	25	63					3.9	
	HSK-A100 WD32.120	71HSKA100WD3212	32	70		120	91		4.3	
	HSK-A100 WD40.120	71HSKA100WD4012	40	80					4.8	



- MILL HOLDER
- ОПРАВКА ДЛЯ ФРЕЗ
- OPRAWKA FREZARSKA
- FRÉZOVACÍ DRŽÁK
- FREZE TUTUCU

DIN 69893 HSK-A
PF

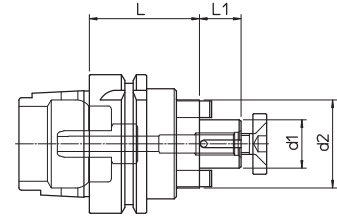

fig.1

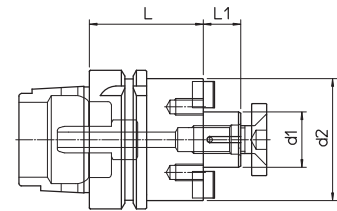

fig.2

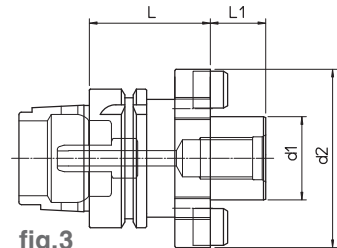
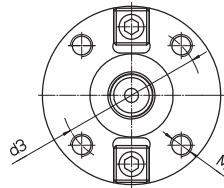
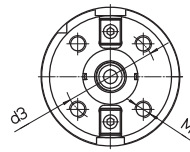

fig.3



- Supplied with coolant tube
- Содержит соединение для хладагента
- Wyposażona w złączkę do cieczy chłodzącej
- Dodávané s chladicím potrubím
- Soğutma sıvısı borusuyla tedarik edilir

HSK-A	REF.	CODE	d ₁	d ₂	d ₃	M	L	L ₁	kg	fig.
63	HSK-A63 PF16.50	71HСКА063PF1605	16	32			50	17	1.1	1
	HSK-A63 PF22.50	71HСКА063PF2205	22	40				19	1.2	
	HSK-A63 PF27.55	71HСКА063PF2705	27	50			55	21	1.4	
	HSK-A63 PF32.60	71HСКА063PF3206	32	60			60	24	1.8	
100	HSK-A100 PF22.65	71HСКА100PF2265	22	40			65	19	2.3	2
	HSK-A100 PF27.65	71HСКА100PF2765	27	50				21	2.5	
	HSK-A100 PF32.70	71HСКА100PF3270	32	60			70	24	2.9	
	HSK-A100 PF40.70	71HСКА100PF4070	40	88	66.7	M12		27	3.3	
	HSK-A100 PF60.75	71HСКА100PF6075	60	128.5	101.6	M16		75	40	

248



240



223



- MORSE TAPER TOOLHOLDER
- ДЕРЖАТЕЛИ С КОНУСОМ МОРСЕ
- OPRAWKA STOŻKOWA MORSE'A
- NÁSTROJOVÝ DRŽÁK S KUŽELEM MORSE
- MORS KONIK TAKIM TUTUCU

DIN 69893 HSK-A
CM - DIN 228 AB

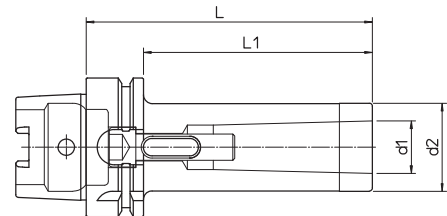

197

HSK-A	REF.	CODE	MORSE	d1	d2	L	L1	kg
63	HSK-A63 CM2.110 A-B	71HSKA063CMB211	2	17.780	32	110	84	2
	HSK-A63 CM3.130 A-B	71HSKA063CMB313	3	23.825	40	130	104	2.2
	HSK-A63 CM4.155 A-B	71HSKA063CMB415	4	31.267	48	155	129	2.6

- TAPPING TOOLHOLDER
- ДЕРЖАТЕЛИ МЕТЧИКОВ
- OPRAWKA GWINTOWNIKA
- ZÁVITOŘEZNÝ NÁSTROJOVÝ DRŽÁK
- DIŞ ÇEKME TAKIMI TUTUCU

DIN 69893 HSK-A
MS

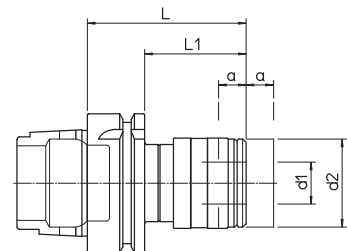

HSK-A	REF.	CODE	d1	d2	L	L1	a	kg
63	HSK-A63 MS1 M3-12	71HSKA063M10312	19	39	72	46	7.5	1
	HSK-A63 MS2 M8-20	71HSKA063M20820	31	60	110	84	10	1.7



- COLLET CHUCK HOLDER
- ЦАНГОВЫЕ ПАТРОНЫ
- OPRAWKA TULEI ZACISKOWEJ
- POUZDROVÝ UPÍNACÍ DRŽÁK
- FREZE ÇAKISI TUTUCULU TORNA AYNASI TUTUCU

DIN 69871 AD+B40
ER - DIN 6499

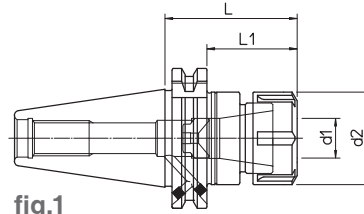

fig.1

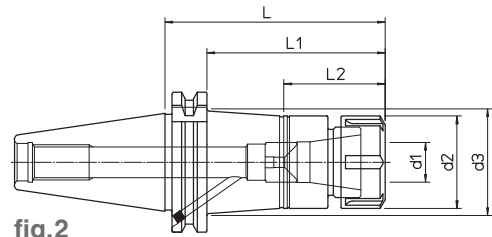

fig.2

- Supplied without collets and clamping wrenches
- Эластичная цанга и зажимный ключ не входят в комплект поставки
- Tuleja elastyczna i klucze zaciskowe nie są na wyposażeniu
- Dodává se bez pouzder a upínacích klíčů
- Freze çakıları ve sıkıştırma anahtarları olmadan teslim edilir

DIN	REF.	CODE	TYPE	d ₁	d ₂	d ₃	L	L ₁	L ₂	kg	fig.
40	DIN69871-AD+B40 ER16.60	71DIN-B40ER1606	ER 16 M	0.5 ~ 10	22	-	60	41	-	0.9	1
	DIN69871-AD+B40 ER16.100	71DIN-B40ER1610				29.5	100	81	41	1	2
	DIN69871-AD+B40 ER16.160	71DIN-B40ER1616				38	160	141	41	2	2
	DIN69871-AD+B40 ER25.60	71DIN-B40ER2506	ER 25	1 ~ 16	42	-	60	41	-	1.1	1
	DIN69871-AD+B40 ER25.100	71DIN-B40ER2510				47	100	81	46	1.6	2
	DIN69871-AD+B40 ER25.160	71DIN-B40ER2516				50	160	141	46	2.1	2
	DIN69871-AD+B40 ER32.70	71DIN-B40ER3207	ER 32	2 ~ 20	50	-	70	51	-	1.2	1
	DIN69871-AD+B40 ER32.110	71DIN-B40ER3211					110	91		1.7	
	DIN69871-AD+B40 ER32.160	71DIN-B40ER3216					160	141		2.7	
	DIN69871-AD+B40 ER40.80	71DIN-B40ER4008	ER 40	3 ~ 26	63	-	80	61	-	1.3	
	DIN69871-AD+B40 ER40.120	71DIN-B40ER4012					120	101		2.3	
DIN69871-AD+B40 ER40.160	71DIN-B40ER4016	160					141	3.3			

249



242-244

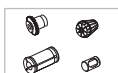

240



223



- COLLET CHUCK HOLDER
- ЦАНГОВЫЕ ПАТРОНЫ
- OPRAWKA TULEI ZACISKOWEJ
- POUZDROVÝ UPÍNACÍ DRŽÁK
- FREZE ÇAKISI TUTUCULU TORNA AYNASI TUTUCU

DIN 69871 AD+B50

ER - DIN 6499

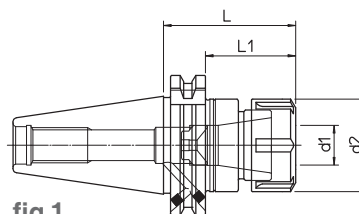

fig.1

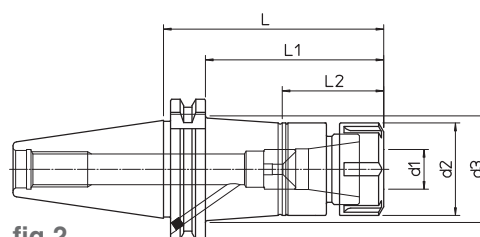

fig.2

199

- Supplied without collets and clamping wrenches
- Эластичная цанга и зажимный ключ не входят в комплект поставки
- Tuleja elastyczna i klucze zaciskowe nie są na wyposażeniu
- Dodáva sa bez pouzder a upínacích kľúčů
- Freze çakıları ve sıkıştırma anahtarları olmadan teslim edilir

DIN	REF.	CODE	TYPE	d1	d2	d3	L	L1	L2	kg	fig.
50	DIN69871-AD+B50 ER16.100	71DIN-B50ER1610	ER 16 M	0.5 ~ 10	22	29.5	100	81	41	2.5	2
	DIN69871-AD+B50 ER16.160	71DIN-B50ER1616				32.5	160	141		3.3	
	DIN69871-AD+B50 ER25.70	71DIN-B50ER2507	ER 25	1 ~ 16	42	-	70	51	-	2.5	1
	DIN69871-AD+B50 ER25.110	71DIN-B50ER2511				48	110	91	46	2.8	
	DIN69871-AD+B50 ER25.160	71DIN-B50ER2516				50	160	141		3.6	
	DIN69871-AD+B50 ER32.70	71DIN-B50ER3207	ER 32	2 ~ 20	50	-	70	51	-	2.9	1
	DIN69871-AD+B50 ER32.110	71DIN-B50ER3211				55	110	91	52	3.4	
	DIN69871-AD+B50 ER32.160	71DIN-B50ER3216				57.5	160	141		4	
	DIN69871-AD+B50 ER40.100	71DIN-B50ER4010	ER 40	3 ~ 26	63	65	100	81	55	3.8	2
	DIN69871-AD+B50 ER40.160	71DIN-B50ER4016				70	160	141		4.3	



- WELDON TOOLHOLDER
- ДЕРЖАТЕЛИ WELDON
- OPRAWKA NARZĘDZIOWA WELDON
- NÁSTROJOVÝ DRŽÁK WELDON
- WELDON TAKIM TUTUCU

DIN 69871 AD+B40
WD - DIN 1835-B

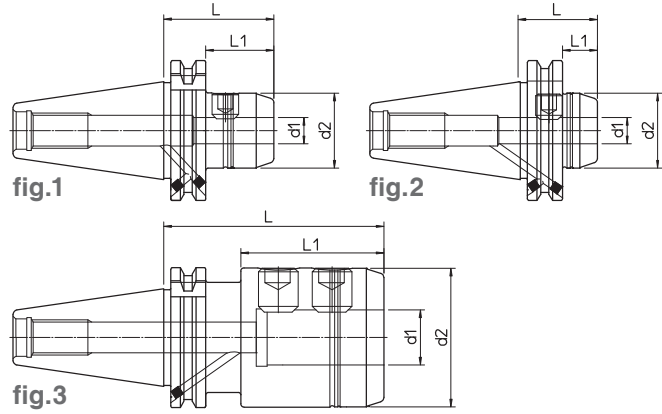

200

DIN	REF.	CODE	d1 ^{H5}	d2	L	L1	kg	fig.
40	DIN69871-AD+B40 WD06.50	71DIN-B40WD0605	6	23	50	31	0.8	1
	DIN69871-AD+B40 WD06.110	71DIN-B40WD0611			110	91	1	
	DIN69871-AD+B40 WD06.160	71DIN-B40WD0616			160	141	1.1	
	DIN69871-AD+B40 WD08.50	71DIN-B40WD0805	8	26	50	31	0.9	
	DIN69871-AD+B40 WD08.110	71DIN-B40WD0811			110	91	1.1	
	DIN69871-AD+B40 WD08.160	71DIN-B40WD0816			160	141	1.3	
	DIN69871-AD+B40 WD10.50	71DIN-B40WD1005	10	30	50	31	1	
	DIN69871-AD+B40 WD10.110	71DIN-B40WD1011			110	91	1.4	
	DIN69871-AD+B40 WD10.160	71DIN-B40WD1016			160	141	1.6	
	DIN69871-AD+B40 WD12.35	71DIN-B40WD1203	12	34	35	16	1	2
	DIN69871-AD+B40 WD12.50	71DIN-B40WD1205			50	31	1.1	1
	DIN69871-AD+B40 WD12.110	71DIN-B40WD1211			110	91	1.4	
	DIN69871-AD+B40 WD12.160	71DIN-B40WD1216			160	141	1.7	
	DIN69871-AD+B40 WD14.50	71DIN-B40WD1405	14	38	50	31	1.2	
	DIN69871-AD+B40 WD14.110	71DIN-B40WD1411			110	91	1.6	
	DIN69871-AD+B40 WD16.35	71DIN-B40WD1603	16	42	35	16	1.1	2
	DIN69871-AD+B40 WD16.63	71DIN-B40WD1606			63	44	1.3	1
	DIN69871-AD+B40 WD16.110	71DIN-B40WD1611			110	91	1.7	
	DIN69871-AD+B40 WD16.160	71DIN-B40WD1616			160	141	2.2	
	DIN69871-AD+B40 WD18.63	71DIN-B40WD1806	18	46	63	44	1.4	
	DIN69871-AD+B40 WD18.110	71DIN-B40WD1811			110	91	1.9	
	DIN69871-AD+B40 WD20.35	71DIN-B40WD2003	20	50	44	35	1.2	2
	DIN69871-AD+B40 WD20.63	71DIN-B40WD2006			63	44	1.5	1
	DIN69871-AD+B40 WD20.110	71DIN-B40WD2011			110	91	2.1	
	DIN69871-AD+B40 WD20.160	71DIN-B40WD2016			160	141	2.6	
	DIN69871-AD+B40 WD25.35	71DIN-B40WD2503	25	63	44	35	1.3	2
	DIN69871-AD+B40 WD25.100	71DIN-B40WD2510			100	65	2	3
	DIN69871-AD+B40 WD25.160	71DIN-B40WD2516			160	125	3.2	
DIN69871-AD+B40 WD32.100	71DIN-B40WD3210	100			65	2.5		
DIN69871-AD+B40 WD32.160	71DIN-B40WD3216	32	70	160	125	3.9		

249



240



223



- WELDON TOOLHOLDER
- ДЕРЖАТЕЛИ WELDON
- OPRAWKA NARZĘDZIOWA WELDON
- NÁSTROJOVÝ DRŽÁK WELDON
- WELDON TAKIM TUTUCU

DIN 69871 AD+B50
WD - DIN 1835-B

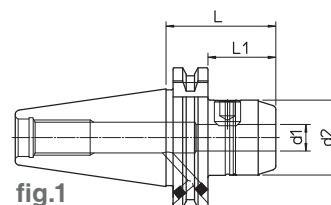

fig.1

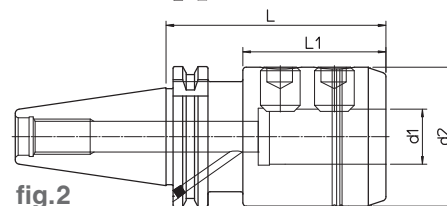
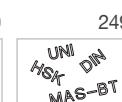
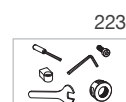

fig.2

201

DIN	REF.	CODE	d1 ^{H5}	d2	L	L1	kg	fig.
50	DIN69871-AD+B50 WD06.63	71DIN-B50WD0606	6	23	63	44	2.3	1
	DIN69871-AD+B50 WD06.110	71DIN-B50WD0611			110	91	2.4	
	DIN69871-AD+B50 WD06.160	71DIN-B50WD0616			160	141	2.5	
	DIN69871-AD+B50 WD08.63	71DIN-B50WD0806	8	26	63	44	2.4	
	DIN69871-AD+B50 WD08.110	71DIN-B50WD0811			110	91	2.5	
	DIN69871-AD+B50 WD08.160	71DIN-B50WD0816			160	141	2.7	
	DIN69871-AD+B50 WD10.63	71DIN-B50WD1006	10	30	63	44	2.5	
	DIN69871-AD+B50 WD10.110	71DIN-B50WD1011			110	91	2.7	
	DIN69871-AD+B50 WD10.160	71DIN-B50WD1016			160	141	2.9	
	DIN69871-AD+B50 WD12.63	71DIN-B50WD1206	12	34	63	44	2.6	
	DIN69871-AD+B50 WD12.110	71DIN-B50WD1211			110	91	2.8	
	DIN69871-AD+B50 WD12.160	71DIN-B50WD1216			160	141	3.2	
	DIN69871-AD+B50 WD14.63	71DIN-B50WD1406	14	38	63	44	2.7	
	DIN69871-AD+B50 WD14.110	71DIN-B50WD1411			110	91	3	
	DIN69871-AD+B50 WD16.63	71DIN-B50WD1606	16	42	63	44	2.8	
	DIN69871-AD+B50 WD16.110	71DIN-B50WD1611			110	91	3.2	
	DIN69871-AD+B50 WD16.160	71DIN-B50WD1616			160	141	3.7	
	DIN69871-AD+B50 WD18.63	71DIN-B50WD1806	18	46	63	44	2.9	
	DIN69871-AD+B50 WD18.110	71DIN-B50WD1811			110	91	3.4	
	DIN69871-AD+B50 WD20.63	71DIN-B50WD2006	20	50	63	44	3	
	DIN69871-AD+B50 WD20.110	71DIN-B50WD2011			110	91	3.6	
	DIN69871-AD+B50 WD20.160	71DIN-B50WD2016			160	141	4.2	
	DIN69871-AD+B50 WD25.80	71DIN-B50WD2508	25	63	80	61	3.5	
	DIN69871-AD+B50 WD25.110	71DIN-B50WD2511			110	91	4.1	
DIN69871-AD+B50 WD25.160	71DIN-B50WD2516	160			141	5.1		
DIN69871-AD+B50 WD32.100	71DIN-B50WD3210	32	70	100	81	4.6		
DIN69871-AD+B50 WD32.160	71DIN-B50WD3216			160	141	6		
DIN69871-AD+B50 WD40.100	71DIN-B50WD4010	40	80	100	81	4.8		
DIN69871-AD+B50 WD40.160	71DIN-B50WD4016			160	141	6.5		



- MILL HOLDER
- ОПРАВКА ДЛЯ ФРЕЗ
- OPRAWKA FREZARSKA
- FRÉZOVACÍ DRŽÁK
- FREZE TUTUCU

DIN 69871 AD+B
PF

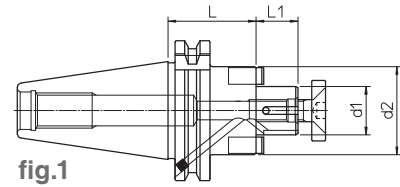

fig.1

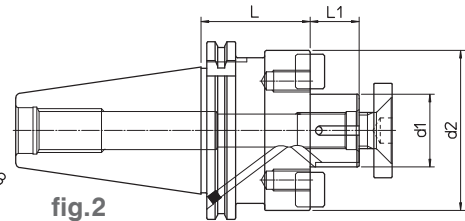
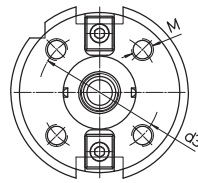

fig.2

202

DIN	REF.	CODE	d1	d2	d3	M	L	L1	kg	fig.			
40	DIN69871-AD+B40 PF16.35	71DIN-B40PF1603	16	32	-	-	35	17	0.9	1			
	DIN69871-AD+B40 PF16.110	71DIN-B40PF1611					110		1.3				
	DIN69871-AD+B40 PF16.160	71DIN-B40PF1616					160		1.9				
	DIN69871-AD+B40 PF22.40	71DIN-B40PF2204	22	40			40	1					
	DIN69871-AD+B40 PF22.110	71DIN-B40PF2211					110	1.7					
	DIN69871-AD+B40 PF22.160	71DIN-B40PF2216					160	2.1					
	DIN69871-AD+B40 PF27.45	71DIN-B40PF2704	27	50			45	1.2					
	DIN69871-AD+B40 PF27.110	71DIN-B40PF2711					110	2.2					
	DIN69871-AD+B40 PF27.160	71DIN-B40PF2716					160	2.9					
	DIN69871-AD+B40 PF32.50	71DIN-B40PF3205	32	60			50	1.7					
	DIN69871-AD+B40 PF32.110	71DIN-B40PF3211					110	3					
DIN69871-AD+B40 PF40.55	71DIN-B40PF4005	40	70	55	2.1								
50	DIN69871-AD+B50 PF16.40	71DIN-B50PF1604	16	32	-	-	40	17	2.4	1			
	DIN69871-AD+B50 PF16.110	71DIN-B50PF1611					110		2.8				
	DIN69871-AD+B50 PF16.160	71DIN-B50PF1616					160		3.1				
	DIN69871-AD+B50 PF22.45	71DIN-B50PF2204	22	40			45	2.6					
	DIN69871-AD+B50 PF22.110	71DIN-B50PF2211					110	3.2					
	DIN69871-AD+B50 PF22.160	71DIN-B50PF2216					160	3.7					
	DIN69871-AD+B50 PF27.50	71DIN-B50PF2705	27	50			50	2.7					
	DIN69871-AD+B50 PF27.110	71DIN-B50PF2711					110	3.6					
	DIN69871-AD+B50 PF27.160	71DIN-B50PF2716					160	4.4					
	DIN69871-AD+B50 PF32.55	71DIN-B50PF3205	32	60			55	3.2					
	DIN69871-AD+B50 PF32.120	71DIN-B50PF3212					120	5.5					
	DIN69871-AD+B50 PF40.60	71DIN-B50PF4006	40	88			66.7	M12	60		27	4.3	2
	DIN69871-AD+B50 PF40.120	71DIN-B50PF4012							120			7.1	
DIN69871-AD+B50 PF60.70	71DIN-B50PF6007	60			128.5	101.6			M16	70		40	

249



240



223



- MORSE TAPER TOOLHOLDER
- ДЕРЖАТЕЛИ С КОНУСОМ MORSE
- OPRAWKA STOŻKOWA MORSE'A
- NÁSTROJOVÝ DRŽÁK S KUŽELEM MORSE
- MORS KONIK TAKIM TUTUCU

DIN 69871 AD+B
CM - DIN 228 AB

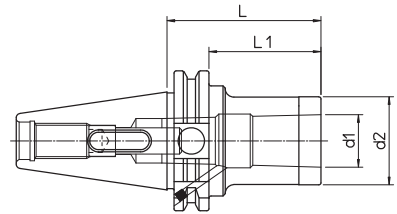

DIN	REF.	CODE	MORSE	d1	d2	L	L1	kg
40	DIN69871-AD+B40 CM2.50 A-B	71DIN-B40CMB205	2	17.780	32	50	31	1
	DIN69871-AD+B40 CM2.125 A-B	71DIN-B40CMB212				125	106	1.4
	DIN69871-AD+B40 CM3.70 A-B	71DIN-B40CMB307	3	23.825	40	70	51	1.1
	DIN69871-AD+B40 CM3.140 A-B	71DIN-B40CMB314				42	140	121
50	DIN69871-AD+B50 CM2.60 A-B	71DIN-B50CMB206	2	17.780	32	60	41	2.6
	DIN69871-AD+B50 CM2.125 A-B	71DIN-B50CMB212				125	106	2.8
	DIN69871-AD+B50 CM3.60 A-B	71DIN-B50CMB306	3	23.825	40	60	41	2.7
	DIN69871-AD+B50 CM3.140 A-B	71DIN-B50CMB314				42	140	121
	DIN69871-AD+B50 CM4.80 A-B	71DIN-B50CMB408	4	31.267	48	80	61	2.9

203

- TAPPING TOOLHOLDER
- ДЕРЖАТЕЛИ МЕТЧИКОВ
- OPRAWKA GWINTOWNIKA
- ZÁVITOŘEZNÝ NÁSTROJOVÝ DRŽÁK
- DIŞ ÇEKME TAKIMI TUTUCU

DIN 69871 A
MS

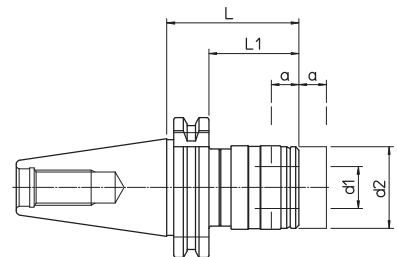

DIN	REF.	CODE	d1	d2	L	L1	a	kg
40	DIN69871-A40 MS1 M3-12	71DIN-A40M10312	19	36	60	40.9	7.5	0.9
	DIN69871-A40 MS2 M8-20	71DIN-A40M20820	31	53	98	78.9	12.5	1.3
50	DIN69871-A50 MS1 M3-12	71DIN-A50M10312	19	38	62	42.9	7.5	2.8
	DIN69871-A50 MS2 M8-20	71DIN-A50M20820	31	53	84	64.9	12.5	3.1
	DIN69871-A50 MS3 M14-33	71DIN-A50M31433	48	78	139	119.9	20	4.3



- COLLET CHUCK HOLDER
- ЦАНГОВЫЕ ПАТРОНЫ
- OPRAWKA TULEI ZACISKOWEJ
- POUZDROVÝ UPÍNACÍ DRŽÁK
- FREZE ÇAKISI TUTUCULU TORNA AYNASI TUTUCU

MAS 403 BT40 AD+B ER - DIN 6499

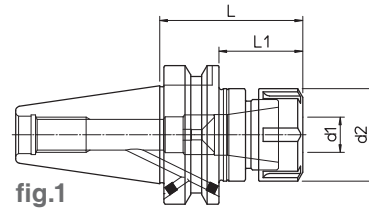

fig.1

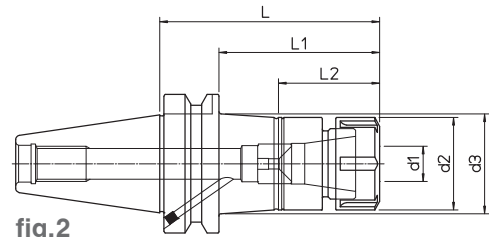

fig.2

- Supplied without collets and clamping wrenches
- Эластичная цанга и зажимный ключ не входят в комплект поставки.
- Tuleja elastyczna i klucze zaciskowe nie są na wyposażeniu
- Dodává se bez pouzder a upínacích klíčů
- Freze çakıları ve sıkıştırma anahtarları olmadan teslim edilir

BT	REF.	CODE	TYPE	d1	d2	d3	L	L1	L2	kg	fig.
40	MAS403 BT40-AD+B ER16.60	71MBT-B40ER1606	ER 16 M	0.5 ~ 10	22	-	60	33	-	1	1
	MAS403 BT40-AD+B ER16.100	71MBT-B40ER1610				28	100	73	41	1.1	2
	MAS403 BT40-AD+B ER16.160	71MBT-B40ER1616				36.5	160	133	-	2.1	-
	MAS403 BT40-AD+B ER25.65	71MBT-B40ER2506	ER 25	1 ~ 16	42	-	65	38	-	1.2	1
	MAS403 BT40-AD+B ER25.100	71MBT-B40ER2510				45.5	100	73	46	1.7	2
	MAS403 BT40-AD+B ER25.160	71MBT-B40ER2516				49.5	160	133	-	2.2	-
	MAS403 BT40-AD+B ER32.70	71MBT-B40ER3207	ER 32	2 ~ 20	50	-	70	43	-	1.3	1
	MAS403 BT40-AD+B ER32.110	71MBT-B40ER3211				110	83	-	1.8		
	MAS403 BT40-AD+B ER32.160	71MBT-B40ER3216				160	133	-	2.8		
	MAS403 BT40-AD+B ER40.80	71MBT-B40ER4008	ER 40	3 ~ 26	63	-	80	53	-	1.4	1
	MAS403 BT40-AD+B ER40.120	71MBT-B40ER4012				120	93	-	2.4		
	MAS403 BT40-AD+B ER40.160	71MBT-B40ER4016				160	133	-	3.4		

249



242-244

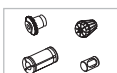

240

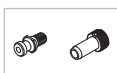

223



- COLLET CHUCK HOLDER
- ЦАНГОВЫЕ ПАТРОНЫ
- OPRAWKA TULEI ZACISKOWEJ
- POUZDROVÝ UPÍNACÍ DRŽÁK
- FREZE ÇAKISI TUTUCULU TORNA AYNASI TUTUCU

MAS 403 BT50 AD+B
ER - DIN 6499

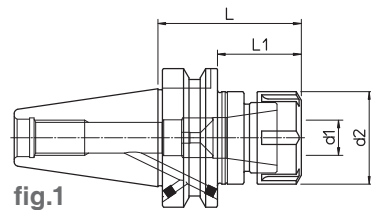

fig.1

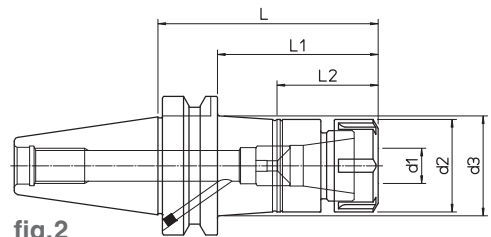
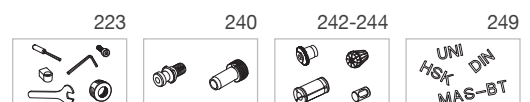

fig.2

205

- Supplied without collets and clamping wrenches
- Эластичная цанга и зажимный ключ не входят в комплект поставки.
- Tuleja elastyczna i klucze zaciskowe nie są na wyposażeniu
- Dodává se bez pouzder a upínacích klíčů
- Freze çakıları ve sıkıştırma anahtarları olmadan teslim edilir

BT	REF.	CODE	TYPE	d ₁	d ₂	d ₃	L	L ₁	L ₂	kg	fig.
50	MAS403 BT50-AD+B ER16.100	71MBT-B50ER1610	ER 16 M	0.5 ~ 10	22	26.5	100	62	41	3.6	2
	MAS403 BT50-AD+B ER16.160	71MBT-B50ER1616				31	160	122		4.3	
	MAS403 BT50-AD+B ER25.75	71MBT-B50ER2507	ER 25	1 ~ 16	42	-	75	37	-	3.5	1
	MAS403 BT50-AD+B ER25.110	71MBT-B50ER2511				45.5	110	72	46	3.8	2
	MAS403 BT50-AD+B ER25.160	71MBT-B50ER2516				48.5	160	122		4.6	
	MAS403 BT50-AD+B ER32.80	71MBT-B50ER3208	ER 32	2 ~ 20	50	-	80	42	-	3.9	1
	MAS403 BT50-AD+B ER32.110	71MBT-B50ER3211				52.5	110	72	52	4.4	2
	MAS403 BT50-AD+B ER32.160	71MBT-B50ER3216				56	160	122		5	
	MAS403 BT50-AD+B ER40.100	71MBT-B50ER4010				ER 40	3 ~ 26	63	-	100	62
	MAS403 BT50-AD+B ER40.160	71MBT-B50ER4016	68.5	160	122				55	5.3	2



- WELDON TOOLHOLDER
- ДЕРЖАТЕЛИ WELDON
- OPRAWKA NARZĘDZIOWA WELDON
- NÁSTROJOVÝ DRŽÁK WELDON
- WELDON TAKIM TUTUCU

MAS 403 BT40 AD+B WD - DIN 1835-B

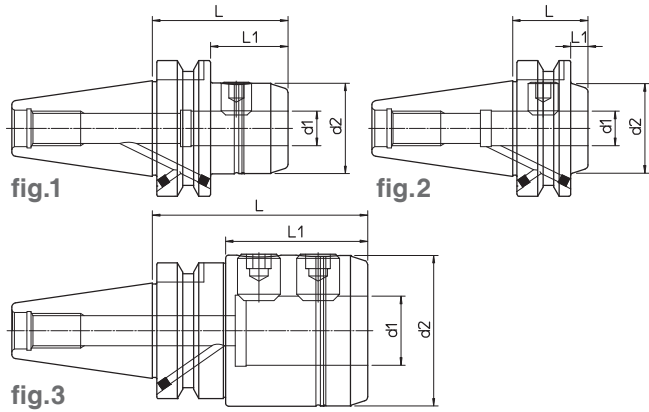

206

BT	REF.	CODE	d1 ^{H5}	d2	L	L1	kg	fig.
40	MAS403 BT40-AD+B WD06.50	71MBT-B40WD0605	6	23	50	23	0.8	1
	MAS403 BT40-AD+B WD06.110	71MBT-B40WD0611			110	83	0.9	
	MAS403 BT40-AD+B WD06.160	71MBT-B40WD0616			160	133	1.1	
	MAS403 BT40-AD+B WD08.50	71MBT-B40WD0805	8	26	50	23	0.9	
	MAS403 BT40-AD+B WD08.110	71MBT-B40WD0811			110	83	1.1	
	MAS403 BT40-AD+B WD08.160	71MBT-B40WD0816			160	133	1.3	
	MAS403 BT40-AD+B WD10.56	71MBT-B40WD1005	10	30	56	29	1	
	MAS403 BT40-AD+B WD10.110	71MBT-B40WD1011			110	83	1.2	
	MAS403 BT40-AD+B WD10.160	71MBT-B40WD1016			160	133	1.5	
	MAS403 BT40-AD+B WD12.35	71MBT-B40WD1203	12	34	35	8	0.9	2
	MAS403 BT40-AD+B WD12.56	71MBT-B40WD1205			56	29	1.1	1
	MAS403 BT40-AD+B WD12.110	71MBT-B40WD1211			110	83	1.4	
	MAS403 BT40-AD+B WD12.160	71MBT-B40WD1216			160	133	1.7	
	MAS403 BT40-AD+B WD14.56	71MBT-B40WD1405	14	38	56	29	1.2	
	MAS403 BT40-AD+B WD14.110	71MBT-B40WD1411			110	83	1.6	
	MAS403 BT40-AD+B WD16.35	71MBT-B40WD1603	16	42	35	8	1	2
	MAS403 BT40-AD+B WD16.63	71MBT-B40WD1606			63	36	1.3	1
	MAS403 BT40-AD+B WD16.110	71MBT-B40WD1611			110	83	1.7	
	MAS403 BT40-AD+B WD16.160	71MBT-B40WD1616			160	133	2.2	
	MAS403 BT40-AD+B WD18.63	71MBT-B40WD1806	18	46	63	36	1.4	
	MAS403 BT40-AD+B WD18.110	71MBT-B40WD1811			110	83	1.9	
	MAS403 BT40-AD+B WD20.35	71MBT-B40WD2003	20	50	35	8	1.1	2
	MAS403 BT40-AD+B WD20.63	71MBT-B40WD2006			63	36	1.5	1
	MAS403 BT40-AD+B WD20.110	71MBT-B40WD2011			110	83	2.1	
MAS403 BT40-AD+B WD20.160	71MBT-B40WD2016	160			133	2.6		
MAS403 BT40-AD+B WD25.35	71MBT-B40WD2503	25	63	35	8	1	2	
MAS403 BT40-AD+B WD25.100	71MBT-B40WD2510			100	73	2	3	
MAS403 BT40-AD+B WD25.160	71MBT-B40WD2516			160	133	3.2		
MAS403 BT40-AD+B WD32.100	71MBT-B40WD3210			100	67	2.5		
MAS403 BT40-AD+B WD32.160	71MBT-B40WD3216	32	70	160	127	3.9		

249



240

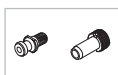

223



- WELDON TOOLHOLDER
- ДЕРЖАТЕЛИ WELDON
- OPRAWKA NARZĘDZIOWA WELDON
- NÁSTROJOVÝ DRŽÁK WELDON
- WELDON TAKIM TUTUCU

MAS 403 BT50 AD+B
WD - DIN 1835-B

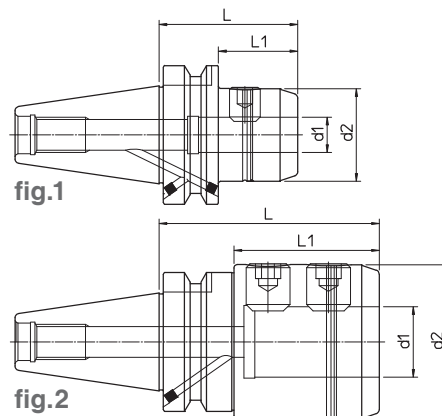

207

BT	REF.	CODE	d ₁ ^{H5}	d ₂	L	L ₁	kg	fig.
50	MAS403 BT50-AD+B WD06.63	71MBT-B50WD0606	6	23	63	25	2.3	1
	MAS403 BT50-AD+B WD06.110	71MBT-B50WD0611			110	72	2.4	
	MAS403 BT50-AD+B WD06.160	71MBT-B50WD0616			160	122	2.6	
	MAS403 BT50-AD+B WD08.63	71MBT-B50WD0806	8	26	63	25	2.4	
	MAS403 BT50-AD+B WD08.110	71MBT-B50WD0811			110	72	2.5	
	MAS403 BT50-AD+B WD08.160	71MBT-B50WD0816			160	122	2.7	
	MAS403 BT50-AD+B WD10.70	71MBT-B50WD1007	10	30	70	32	3	
	MAS403 BT50-AD+B WD10.110	71MBT-B50WD1011			110	72	3.2	
	MAS403 BT50-AD+B WD10.160	71MBT-B50WD1016			160	122	3.4	
	MAS403 BT50-AD+B WD12.70	71MBT-B50WD1207	12	34	70	32	3.1	
	MAS403 BT50-AD+B WD12.110	71MBT-B50WD1211			110	72	3.3	
	MAS403 BT50-AD+B WD12.160	71MBT-B50WD1216			160	122	3.6	
	MAS403 BT50-AD+B WD14.70	71MBT-B50WD1407	14	38	70	32	3.2	
	MAS403 BT50-AD+B WD14.110	71MBT-B50WD1411			110	72	3.5	
	MAS403 BT50-AD+B WD16.80	71MBT-B50WD1608	16	42	80	42	3.3	
	MAS403 BT50-AD+B WD16.110	71MBT-B50WD1611			110	72	3.5	
	MAS403 BT50-AD+B WD16.160	71MBT-B50WD1616			160	122	4	
	MAS403 BT50-AD+B WD18.80	71MBT-B50WD1808	18	46	80	42	3.4	
	MAS403 BT50-AD+B WD18.110	71MBT-B50WD1811			110	72	3.7	
	MAS403 BT50-AD+B WD20.80	71MBT-B50WD2008	20	50	80	42	3.5	
	MAS403 BT50-AD+B WD20.110	71MBT-B50WD2011			110	72	3.8	
	MAS403 BT50-AD+B WD20.160	71MBT-B50WD2016			160	122	4.5	
	MAS403 BT50-AD+B WD25.100	71MBT-B50WD2510	25	63	100	62	4.5	
	MAS403 BT50-AD+B WD25.125	71MBT-B50WD2512			125	87	5	
MAS403 BT50-AD+B WD25.160	71MBT-B50WD2516	160			122	5.7		
MAS403 BT50-AD+B WD32.100	71MBT-B50WD3210	32	70	100	62	5.6		
MAS403 BT50-AD+B WD32.160	71MBT-B50WD3216			160	122	7		
MAS403 BT50-AD+B WD40.110	71MBT-B50WD4011	40	80	110	72	5.8		
MAS403 BT50-AD+B WD40.160	71MBT-B50WD4016			160	122	7.4		
								2



- MILL HOLDER
- ОПРАВКА ДЛЯ ФРЕЗ
- OPRAWKA FREZARSKA
- FRÉZOVACÍ DRŽÁK
- FREZE TUTUCU

MAS 403 BT AD+B PF

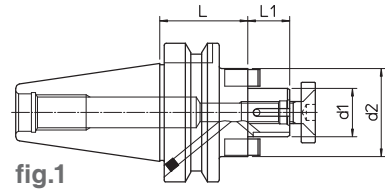

fig.1

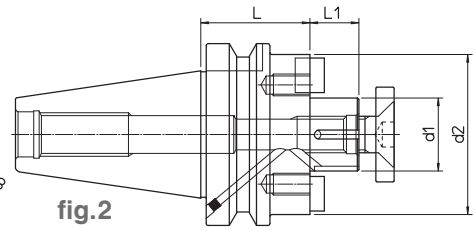
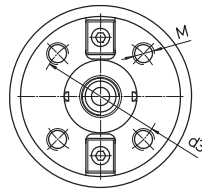

fig.2

208

BT	REF.	CODE	d1	d2	d3	M	L	L1	kg	fig.
40	MAS403 BT40-AD+B PF16.40	71MBT-B40PF1604	16	32	-	-	40	17	0.9	1
	MAS403 BT40-AD+B PF16.110	71MBT-B40PF1611					110		1.3	
	MAS403 BT40-AD+B PF16.160	71MBT-B40PF1616					160		1.6	
	MAS403 BT40-AD+B PF22.40	71MBT-B40PF2204	22	40			40	19	1	
	MAS403 BT40-AD+B PF22.110	71MBT-B40PF2211					110		1.6	
	MAS403 BT40-AD+B PF22.160	71MBT-B40PF2216					160		2.1	
	MAS403 BT40-AD+B PF27.45	71MBT-B40PF2704	27	50			45	21	1.2	
	MAS403 BT40-AD+B PF27.110	71MBT-B40PF2711					110		2.2	
	MAS403 BT40-AD+B PF27.160	71MBT-B40PF2716					160		2.9	
	MAS403 BT40-AD+B PF32.50	71MBT-B40PF3205	32	60			50	24	1.7	
	MAS403 BT40-AD+B PF32.110	71MBT-B40PF3211					110		3	
	MAS403 BT40-AD+B PF40.55	71MBT-B40PF4005					55		2.1	
	50	MAS403 BT50-AD+B PF16.50	71MBT-B50PF1605	16			32	50	17	
MAS403 BT50-AD+B PF16.110		71MBT-B50PF1611	110		2.8					
MAS403 BT50-AD+B PF16.160		71MBT-B50PF1616	160		3.1					
MAS403 BT50-AD+B PF22.50		71MBT-B50PF2205	22	40	50	19	2.6			
MAS403 BT50-AD+B PF22.110		71MBT-B50PF2211			110		3.2			
MAS403 BT50-AD+B PF22.160		71MBT-B50PF2216			160		3.7			
MAS403 BT50-AD+B PF27.55		71MBT-B50PF2705	27	50	55	21	2.7			
MAS403 BT50-AD+B PF27.110		71MBT-B50PF2711			110		3.6			
MAS403 BT50-AD+B PF27.160		71MBT-B50PF2716			160		4.3			
MAS403 BT50-AD+B PF32.55		71MBT-B50PF3205	32	60	55	24	3.2			
MAS403 BT50-AD+B PF32.120		71MBT-B50PF3212			120		5.5			
MAS403 BT50-AD+B PF40.60		71MBT-B50PF4006			60		4.3			
MAS403 BT50-AD+B PF40.120		71MBT-B50PF4012	40	88	66.7	M12	120	7.1	2	
MAS403 BT50-AD+B PF60.80	71MBT-B50PF6008	60	128.5	101.6	M16	80	40	6.8		

249



240



223



- MORSE TAPER TOOLHOLDER
- ДЕРЖАТЕЛИ С КОНУСОМ MORSE
- OPRAWKA STOŻKOWA MORSE'A
- NÁSTROJOVÝ DRŽÁK S KUŽELEM MORSE
- MORS KONIK TAKIM TUTUCU

MAS 403 BT AD+B CM - DIN 228 AB

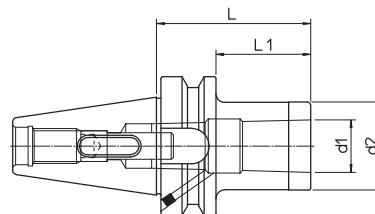

209

BT	REF.	CODE	MORSE	d ₁	d ₂	L	L ₁	kg
40	MAS403 BT40-AD+B CM2.50 A-B	71MBT-B40CMB205	2	17.780	32	50	23	1
	MAS403 BT40-AD+B CM2.125 A-B	71MBT-B40CMB212				125	98	1.3
	MAS403 BT40-AD+B CM3.70 A-B	71MBT-B40CMB307	3	23.825	40	70	43	1.1
	MAS403 BT40-AD+B CM3.140 A-B	71MBT-B40CMB314				140	113	1.5
50	MAS403 BT50-AD+B CM2.60 A-B	71MBT-B50CMB206	2	17.780	32	60	22	2.6
	MAS403 BT50-AD+B CM2.125 A-B	71MBT-B50CMB212				125	87	2.8
	MAS403 BT50-AD+B CM3.60 A-B	71MBT-B50CMB306	3	23.825	40	60	22	2.7
	MAS403 BT50-AD+B CM3.145 A-B	71MBT-B50CMB314				145	107	3.2
	MAS403 BT50-AD+B CM4.80 A-B	71MBT-B50CMB408	4	31.267	48	80	42	2.9

- TAPPING TOOLHOLDER
- ДЕРЖАТЕЛИ МЕТЧИКОВ
- OPRAWKA GWINTOWNIKA
- ZÁVITOŘEZNÝ NÁSTROJOVÝ DRŽÁK
- DIŞ ÇEKME TAKIMI TUTUCU

MAS 403 BT MS

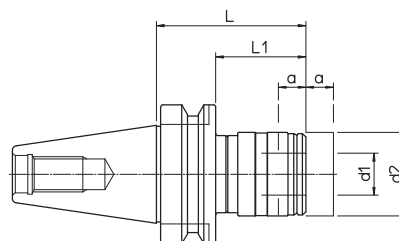

BT	REF.	CODE	d ₁	d ₂	L	L ₁	a	kg
40	MAS403 BT40 MS1 M3-12	71MBT-40-M10312	19	36	67.5	40.5	7.5	0.9
	MAS403 BT40 MS2 M8-20	71MBT-40-M20820	31	53	94.5	67.5	12.5	1.3
50	MAS403 BT50 MS1 M3-12	71MBT-50-M10312	19	38	80	42	7.5	2.8
	MAS403 BT50 MS2 M8-20	71MBT-50-M20820	31	53	102.5	64.5	12.5	3.1
	MAS403 BT50 MS3 M14-33	71MBT-50-M31433	48	78	154.5	116.5	20	4.3

